



# Ibla

4 COLOURS

5 SIZES

3 SURFACES

Ibla is a latest-generation porcelain stoneware series with an extremely rich assortment, offering the architect countless potentials for use, all perfectly matchable as the basis for architectural projects with the highest technical and aesthetic values, as a great creative tradition is paired with Italian excellence in technological and production innovation.

CERAMICHE **PIEMME**

FLOOR AND MORE

Ibla è una serie in gres porcellanato di ultima generazione, estremamente ricca nell'assortimento che offre al progettista innumerevoli soluzioni d'utilizzo, tutte perfettamente coordinabili tra loro per realizzare un progetto architettonico di altissimo livello sotto l'aspetto sia tecnico che estetico, coniugando la grande tradizione creativa all'eccellente innovazione tecnologica e produttiva Italiana.

Ibla ist eine Feinsteinzeugserie, die dem jüngsten Stand der Technik entspricht. Ihr umfangreiches Sortiment bietet Architekten und Planern zahlreiche, perfekt kombinierbare Lösungen für Architekturprojekte, die technisch und ästhetisch höchste Ansprüche erfüllen, und in denen sich Kreativität mit innovativer Technik und Produktion im Zeichen italienischer Exzellenz verbinden.

Ibla est une série en grès cérame de dernière génération. La grande richesse de son assortiment offre au concepteur d'innombrables solutions d'utilisation, toutes parfaitement coordonnées : c'est l'assurance de pouvoir créer un projet architectural d'un niveau technique et esthétique de haute volée, conjuguant la grande tradition créative avec l'excellence italienne en matière d'innovation, de technologie et de production.

## Ibla



Inspiration & Technology

P. 6

Villa Ibla

P.13

Informazioni Tecniche  
Technical Information

P. 53





La roccia asphaltica è una pietra calcarea tenera impregnata in percentuali variabili di idrocarburi fossili naturali, cioè bitume. Una particolare roccia asphaltica siciliana, nota per i cromatismi che la rendono unica al mondo è la “pietra pece di Ragusa” reperibile in colorazioni che vanno dal grigio chiaro al marrone scuro, fino al nero; la presenza di fossili, le venature e le decise fiammature ne disegnano il carattere superficiale e la profondità cromatica. Grazie alla sua lavorabilità è stata per molti secoli al centro del processo artistico e culturale dell’antica area Ragusana, il cui nucleo storico assunse nei secoli passati il nome di “Ibla”, in quanto gli abitanti che la popolavano, di origine greca, veneravano una dea nota come Dea Iblea. A questa antica storia mediterranea, fatta di persone e di quel materiale che per secoli è stato impiegato per costruire la città, si ricollega il nome di questa collezione in gres porcellanato: Ibla.

Asphalt rock is a soft limestone impregnated with variable percentages of natural fossil hydrocarbons (bitumen). “Pietra Pece”, distinctive to the city of Ragusa, is a special Italian form of asphalt rock known for its unique colouring ranging from pale grey to dark brown and black; its fossils, veining and strong stippling give its surface character and depth of colour. Thanks to its workability, for many centuries it was central to the art and culture of the ancient part of Ragusa, known in past centuries as “Ibla” because its people, of Greek origin, venerated a goddess of that name. This slice of Mediterranean history, with its people and the special material they used to build their city over the centuries, now gives its name to a porcelain stoneware collection: Ibla.

Naturasphalt ist ein weicher Sandstein, der zu unterschiedlichen Anteilen mit fossilen Kohlenwasserstoffen, d.h. mit Bitumen durchtränkt ist. Ein aufgrund seiner Farben weltweit einzigartiger sizilianischer Naturasphalt ist der Pechstein („Pietra Pece“) aus Ragusa, dessen Farbe von Hellgrau über Dunkelbraun bis zu Schwarz reicht. Fossilien, Äderungen und starke Flammungen zeichnen den Oberflächencharakter und die Farbtiefe. Da er sich gut verarbeiten lässt, stand er jahrhundertlang im Mittelpunkt des künstlerischen und kulturellen Schaffens des antiken Stadtgebiets von Ragusa. Der Name „Ibla“ des historischen Kerns stammt von der als Dea Iblea bekannten Göttin, die die Einwohner griechischer Herkunft verehrten. An diese antike mediterrane Geschichte mit ihren Menschen und Baustoffen, wie das über Jahrhunderte hinweg zum Bau der Stadt verwendete Material, knüpft auch der Name dieser Feinsteinzeugkollektion an: Ibla.

La roche asphaltique est un calcaire tendre imprégné en proportions variables d’hydrocarbures fossiles naturels, c’est-à-dire de bitume. La « pierre d’asphalte de Raguse » est une roche asphaltique sicilienne particulière. Elle est connue pour ses couleurs qui la rendent unique au monde, allant du gris clair au marron foncé, et jusqu’au noir. La présence de fossiles, de veinages et d’un flammage marqué en dessine son caractère superficiel et sa profondeur chromatique. Pendant de nombreux siècles, sa maniabilité l’a placée au coeur du processus artistique et culturel de l’ancienne région de Raguse, dont le centre historique s’appelait alors « Ibla », car ses habitants, d’origine grecque, vénéraient la déesse Iblea. Cette collection de grès cérame tire son nom de l’antique histoire méditerranéenne, faite de personnes mais aussi de ce matériau utilisé dans la construction des villes au fil des siècles : Ibla.

# Inspiration & Technology

## Synchro Digit Piemme™

Una Tecnologia Rivoluzionaria  
A Revolutionary Technology  
Eine revolutionäre Technologie  
Une Technologie Révolutionnaire



PAGINA / PAGE

---

Synchronized Digital Structured Surface 6

---

Three-dimensional Relief Decorations 8

---

Ibla  
Inspiration & Technology 5



The Synchro Digit Piemme™ digital surface structure, exclusively developed at the Piemme plants, combined with high resolution printing at 300 DPI, provides a material with a uniquely hyper-realistic appearance and outstanding technical and aesthetic qualities. The soft three-dimensional surface is no longer formed by pressing and is therefore free from the repetitive constraints of classic ceramic moulds; moreover, it is perfectly synchronised with the graphics on the surface.

Die exklusiv in den Piemme Werken entwickelte digitale Synchro Digit Piemme™ Oberflächenstruktur und der Digitaldruck mit einer Auflösung von 300 dpi ermöglichen es, ein Material mit einzigartiger hyperrealistischer Optik und hoher technischer und ästhetischer Wertigkeit zu erhalten. Die weiche, dreidimensionale Oberfläche wird nicht mehr durch Pressen geformt und somit nicht mehr durch die sich wiederholenden, klassischen Fliesen-Pressformen konditioniert; zudem ist sie perfekt auf die Grafik der Oberfläche abgestimmt.

La structure superficielle numérique, développée en exclusivité dans les établissements de Piemme Synchro Digit Piemme™ est associée à l'impression haute résolution à 300 dpi. Ces deux éléments permettent d'obtenir un matériau à l'esthétique hyperréaliste unique et d'une excellente valeur technique et esthétique. La surface tridimensionnelle douce n'est plus formée par pressage et n'est donc pas soumise aux contraintes répétitives des moulages classiques pour céramique ; de plus, elle est parfaitement synchronisée avec le graphique de la surface.

La struttura superficiale digitale sviluppata in esclusiva negli stabilimenti Piemme, Synchro Digit Piemme™, unita alla stampa ad alta risoluzione a 300 dpi, consentono di ottenere un materiale dall'estetica iperrealista unico nel suo genere, di eccellente valenza tecnica ed estetica. La morbida superficie tridimensionale non è più formata per pressatura ed è quindi libera dai vincoli ripetitivi dei classici stampi per ceramica; inoltre è perfettamente sincronizzata con la grafica di superficie.

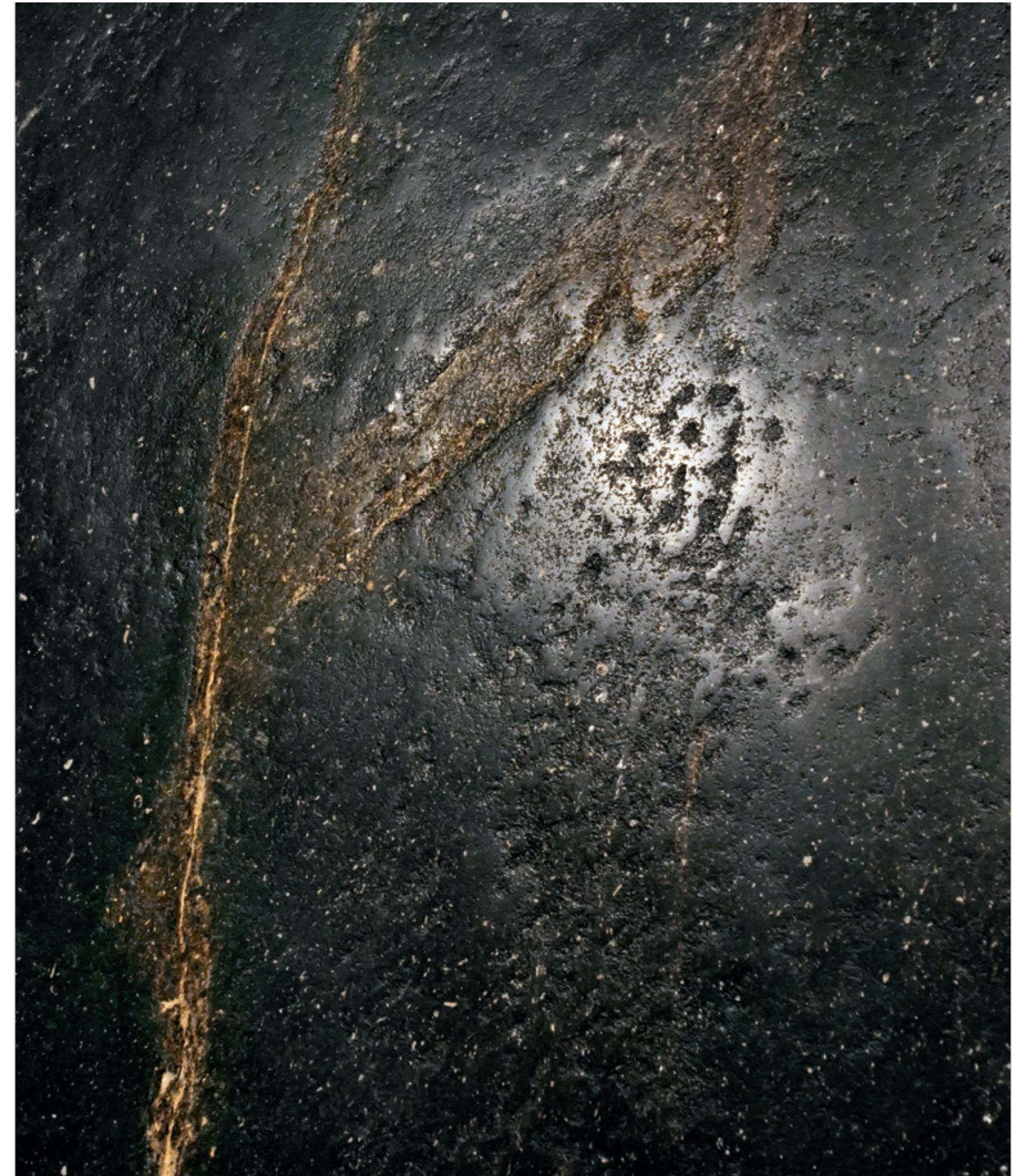



## Decorations in 3D Relief / Three-dimensional Relief Decorations

Special three-dimensional relief decorations with an evident Sicilian inspiration, such as traditional lace that is recalled by the "Tombolo" decoration, or by the "Zagara" flower, are enhanced by the new Synchro Digit Piemme™ three-dimensional decoration technology, thanks to the perfect combination of tactile and visual sensations.

Besondere Dekore mit 3D-Relief von klar sizilianischer Inspiration wie die traditionelle Spitze des Dekors „Tombolo“ oder das Blütenmotiv „Zagara“ werden durch die neue 3D-Dekortechnik Synchro Digit Piemme™ noch hervorgehoben. Dabei werden taktile und visuelle Empfindungen auf vollkommene Weise kombiniert.

Grâce à une parfaite combinaison de sensations tactiles et visuelles, des décors particuliers en relief, clairement inspirés de la Sicile, comme la dentelle traditionnelle rappelée par la décoration « Tombolo » ou la fleur « Zagara », sont mis en valeur par la nouvelle technologie de décoration tridimensionnelle Synchro Digit Piemme™.

60x120 - 24"x48" Tombolo Dark Lappato Rettificato

Particolari decori a rilievo tridimensionale di chiara ispirazione siciliana, come il pizzo tradizionale rievocato dal decoro "Tombolo", o dal fiore "Zagara" sono esaltati dalla nuova tecnologia di decorazione tridimensionale Synchro Digit Piemme™, grazie ad una perfetta combinazione di sensazioni tattili e visive.





60x120 - 24"x48" Tombolo Light Lappato Rettificato



60x120 - 24"x48" Zagara Light Naturale Rettificato





# Villa Ibla

Residential Spaces  
Wohnanlagen  
Espaces Résidentiels



COLORI / COLOURS

AMBIENTI / AMBIENT

PAGINA / PAGE

Ibla Nera	Living	15
Ibla Colofonia	Kitchen	19
Ibla Nera	Dining Room	22
Ibla Nera / Tombolo - Zagara Dark	Bathroom	26
Ibla Colofonia	Patio	30
Ibla Resina	Terrace	34
Ibla Resina	Studio	36
Ibla Linfa / Zagara Light	Studio	39
Ibla Resina / Zagara Mid	Bedroom	40
Ibla Linfa / Tombolo / Zagara Dark	Bathroom	44



## Villa Ibla

The Piemme development laboratory draws inspiration from Ragusa's "Pietra Pece" and offers it in four elegant ceramic variants, ranging from black to white and from grey to beige, and combining it with a home design style focused on the high-grade restoration of historic buildings, with decidedly contemporary inclusions.

Nach dem Vorbild des Pechsteins aus Ragusa entwickelte Piemme eine keramische Interpretation, die in den vier eleganten Farben Schwarz, Weiß, Grau und Beige zur Wahl steht und sich gut zur Umsetzung eines gehobenen Wohnstils im Rahmen von Altbausanierungen, bei denen Tradition auf Moderne trifft, eignen.

Le laboratoire de développement de Piemme propose de nouveau, sous forme céramique, la pierre d'asphalte de Raguse dont elle s'inspire. Elle se décline en quatre variantes élégantes allant du noir au blanc, du gris au beige, associées à un style de design qui s'inscrit dans la réhabilitation de bâtiments anciens de prestige, avec des insertions résolument contemporaines.

Il laboratorio di sviluppo Piemme ripropone in chiave ceramica la pietra pece di Ragusa alla quale si ispira, declinandola in quattro eleganti varianti che spaziano dal nero al bianco, dal grigio al beige ed abbinandole ad uno stile abitativo di pregiato recupero storico con inserimenti decisamente contemporanei.

60x120 - 24"x48" Ibla Nera Lappato Rettificato

30x120 - 12"x48" Ibla Nera Lappato Rettificato



Villa Ibla







## Ibla Colofonia

As well as the most classical 60x120 and 60x60 sizes, the Ibla assortment also includes the long plank size 30x120, which amplifies, amalgamates and infinitely combines the range's fascinating colour effects and can be installed in many layouts as either a floor or a wall covering.

Neben den klassischen Formaten 60x120 cm und 60x60 cm wartet Ibla mit dem neuen schlanken Längsformat 30x120 cm auf, das die Möglichkeiten eines harmonischen Spiels aus Farben und Formaten durch zahlreiche Verlegelösungen für Boden und Wand bis ins Unendliche erweitert.

Outre les formats plus classiques 60x120 et 60x60, Ibla propose dans son assortiment le nouveau format à listel élancé 30x120 qui amplifie, mélange et combine à l'infini les couleurs séduisantes de la gamme avec de nombreuses solutions de pose, tant pour les revêtements de sol que pour les revêtements muraux.

Oltre ai formati 60x120 e 60x60, Ibla offre in assortimento il nuovo formato a listone slanciato 30x120 che amplifica, amalgama e combina all'infinito gli affascinanti cromatismi in gamma con numerose soluzioni di posa sia da pavimento che per rivestimento murale.

60x60 - 24"x24" Ibla Colofonia Lappato Rettificato

30x120 - 12"x48" Ibla Colofonia Naturale Rettificato  
30x30 - 12"x12" Ragusa Ibla Colofonia Mix Lappato Naturale





## Ibla Colofonia

The particular surface lapping emphasises the immense textured depth of the warm hues of Ibla.  
The distressed effect provided by the polishing of the relief surfaces adds a distinctive beauty to interiors.

Die effektiv geläppte Oberfläche bringt die große stoffliche Tiefe der warmen Nuancen von Ibla noch besser zur Geltung.  
Der durch das Polieren der reliefierten Oberflächen erzielte Antikeffekt verleiht dem Ambiente besonderen Charme.

Le polissage particulier de la surface accentue la profondeur matérielle des nuances chaudes de Ibla.  
L'effet vieilli obtenu par le polissage des surfaces en relief confère un charme particulier aux espaces.

La particolare lappatura superficiale esalta la grande profondità materica delle calde nuance di Ibla. L'effetto anticato reso possibile dalla delicata lucidatura della superficie conferisce particolare fascino all'ambiente.

60x60 - 24"x24" Ibla Colofonia Lappato Rettificato









## Ibla Nera

The exquisite small plank 10x60 and chevron 10x53 sizes are the basis respectively for Italian (right-angle block) and French (chevron) herringbone patterns, both very popular in today's interior design; this modern reinterpretation of these great classics enables their use in modern, warm, sophisticated design schemes.

Das Riemchenformat 10x60 cm und das Chevron Format 10x53 cm lassen sich jeweils im italienischen oder französischen Fischgrätmuster, das im Interior Design ein Comeback erlebt, verlegen. Als moderne Umsetzung von zwei Klassikern spielen sie ihre wertige Ausstrahlung für raffinierte Raumgestaltungen mit moderner, wohnlicher Atmosphäre aus.

Les précieux formats à petit listel 10x60 et le chevron 10x53 peuvent être respectivement posés en bâtons rompus à l'italienne ou à la française, un style redevenu très actuel dans la décoration intérieure, qui s'inspire de deux grands classiques et les repropose dans une veine moderne dans des espaces au style chaleureux, actuel et recherché.

I preziosi formati a Listoncino 10x60 e lo Chevron 10x53, consentono rispettivamente la posa a spina all'italiana o alla francese; uno stile rientrato nella grande attualità dell'interior design, attingendo da due grandi classici e riproponendoli in chiave moderna per l'utilizzo in ambienti dallo stile caldo, attuale e ricercato.

10x60 - 4"x24" Listoncino Ibla Nera Lappato Rettificato









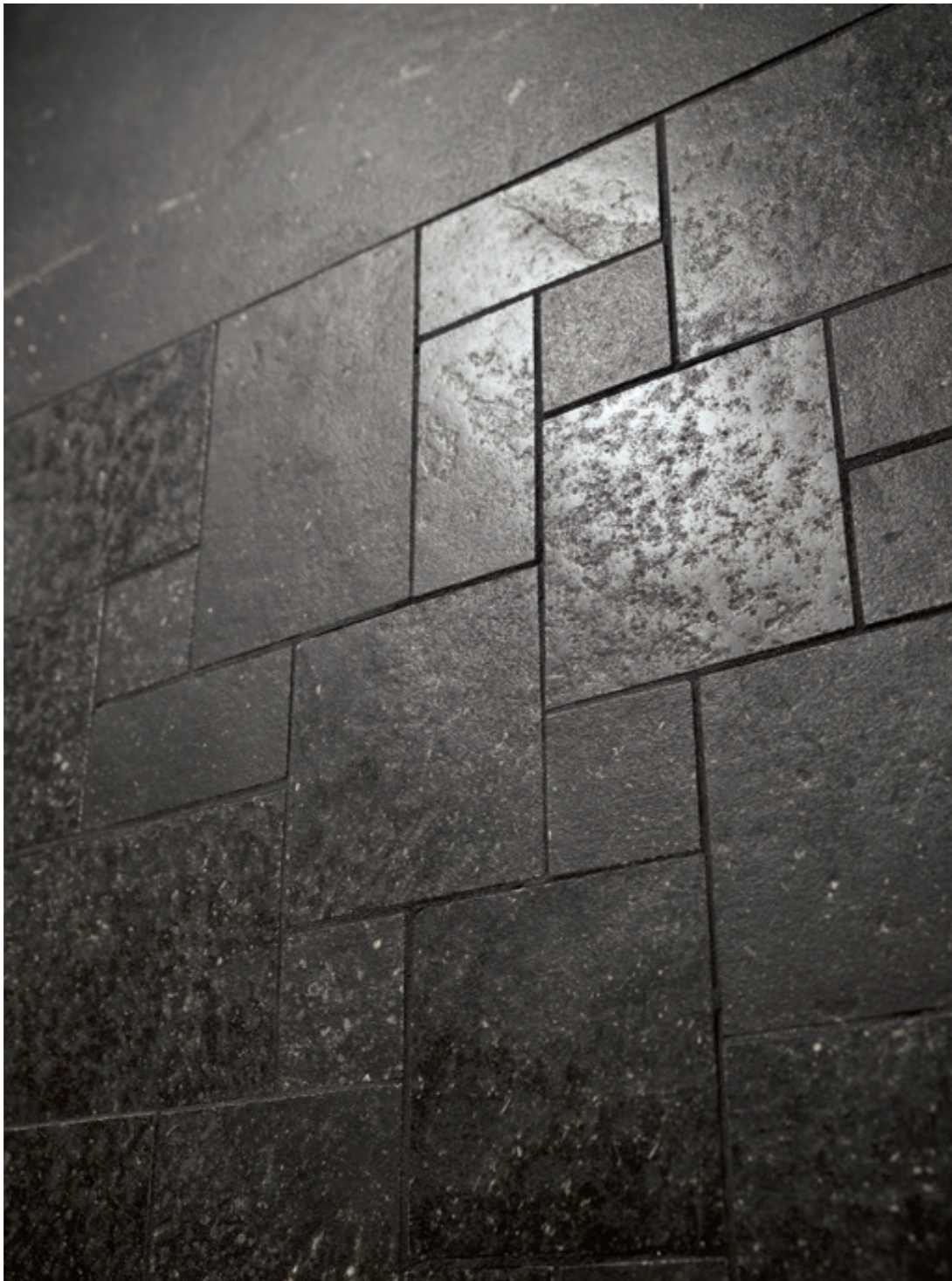







## Ibla Colofonia

The specific "Ragusa" mosaic created with a double natural and lapped surface is in a position to maximise the design in any setting.

Das außergewöhnliche Mosaik „Ragusa“ mit seinem doppelten Oberflächeneffekt (natur und geläpft) unterstreicht das Raumdesign effektiv.

La mosaïque spéciale « Ragusa » réalisée en surface double, naturelle et lappata, est capable de mettre en valeur au mieux le design de chaque espace.

30×120 - 12"×48" Ibla Colofonia Naturale Rettificato

30×30 - 12"×12" Ragusa Ibla Colofonia Mix Lappato Naturale

Il particolare mosaico  
"Ragusa" realizzato a doppia  
superficie naturale e lappata  
è in grado di valorizzare al  
massimo il design di ogni ambiente.





## Ibla Resina

Ibla is a concentrate of perfect, state-of-the-art ceramic applications, able to add value to any location with modern, elegant details while delivering the highest technical performances in terms of strength, frost-resistance, non-absorbency and hygiene offered by modern porcelain stoneware, manufactured in state-of-the-art plants and compliant with the highest international quality standards.

Ibla bietet innovative keramischen Lösungen, die jedes Ambiente mit trendigen und eleganten Details aufwerten und gleichzeitig die technischen Vorzüge von modernem Feinsteinzeug bieten, das resistent, frostbeständig, wasserabweisend und gesundheitlich unbedenklich ist und in technologisch zukunftsweisenden Werken gefertigt wird, um höchste internationale Qualitätsstandards zu erfüllen.

Ibla représente un concentré d'applications céramiques d'avant-garde parfaites : capables de mettre en valeur tout espace par des détails modernes et élégants, elles assurent aussi les performances techniques maximales en termes de résistance, d'ingéivité, de non-absorption et de salubrité du grès cérame moderne, produit dans des installations ultra-technologiques et dans le respect des normes de qualité internationales les plus élevées.

Ibla rappresenta un concentrato di perfette applicazioni ceramiche d'avanguardia capaci di valorizzare ogni ambiente con dettagli moderni ed eleganti al tempo stesso, oltre a garantire le più elevate prestazioni tecniche di resistenza, ingelività, inassorbenza e salubrità del moderno gres porcellanato, realizzato in stabilimenti ultra tecnologici e rispettoso dei più elevati standard qualitativi internazionali.

10×60 - 4"×24" Listoncino Ibla Resina Naturale Rettificato





















Ibla Linfa / Tombolo Dark - Light / Zagara Dark

60x120- 24"x48" Ibla Linfa Naturale Rettificato  
60x120 - 24"x48" Tombolo Dark - Light Lap/Ret  
28,2x28,5 - 11"x11¼" Opus Linfa Mix Lappato/Naturale



30x120 - 12"x48" Ibla Linfa Lap/Ret - Ibla Nera Nat/Ret  
60x120 - 24"x48" Zagara Dark Naturale Rettificato









Ibla Linfa / Tombolo Dark - Light

60x120 - 24"x48" Ibla Linfa Naturale Rettificato  
60x120 - 24"x48" Tombolo Dark Lappato Rettificato



60x120 - 24"x48" Tombolo Light Lappato Rettificato

30x120 - 12"x48" Ibla Linfa Lappato Rettificato





## Ibla Linfa

The "Ragusa" and "Opus" distinctive craft-inspired mosaics, available in two finishes, natural and honed, beautify interiors and create warm, enticing ambiances.

Das besondere Design der Mosaik „Ragusa“ und „Opus“, die in den zwei Oberflächenausführungen natürlich und geläpft angeboten werden, verbreitet handwerkliches Flair und schafft eine behagliche Raumatmosphäre.

Les mosaïques spéciales de caractère artisanal comme « Ragusa » et « Opus », réalisées avec une double surface, naturelle et lappata, embellissent les espaces en créant des atmosphères chaleureuses et enveloppantes.

I particolari mosaici di foggia artigianale come "Opus" e "Ragusa" realizzati a doppia superficie, naturale e lappata, impreziosiscono l'ambiente creando atmosfere calde ed avvolgenti.

60x120 - 24"x48" Ibla Linfa Naturale Rettificato

28,2x28,5 - 11"x11¼" Opus Ibla Linfa Mix Lappato Naturale





# Informazioni Tecniche

4

Colori  
Colours  
Farben  
Couleurs

Ibla Linfa



Ibla Colofonia

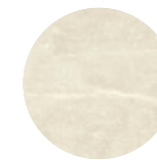

Ibla Resina



Ibla Nera

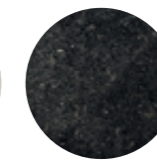

5

Formati  
Sizes  
Formate  
Formats

60×120  
24"×48"



30×120  
12"×48"



60×60  
24"×24"



10×60  
4"×24"



10×53  
4"×20"



1

Spessori  
Thickness  
Stärke  
Epaisseur

±9,5

3

Superfici  
Surfaces  
Oberflächen  
Surfaces

Naturale

Lappato

Antislip

1

Strutture 3D  
3D structures  
Strukturen  
Décorations en relief

Tombolo

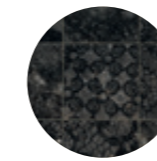

i



**Tecnologia - Technology - Technologie:**  
**Synchro Digit Piemme™**  
Superficie con struttura digitale sincronizzata  
Synchronized digital structured surface  
Im synchronisierten Digitaldruckverfahren  
hergestellte 3D-Oberfläche  
Surface avec texture et finition par  
impression numérique synchronisée

Gres fine porcellanato ad impasto colorato  
Coloured-body fine porcelain stoneware  
Feinsteinzeug aus farbiger Masse  
Grès cérame fin à pâte colorée

Effetto Pietra  
Stone Look  
Natursteinoptik  
Effet Pierre

Rivestimento  
Wall Tiles  
Wandfliesen  
Revêtement

Pavimento  
Floor Tiles  
Bodenfliesen  
Sol





# Ibla Linfa

Per un risultato di posa ottimale si consiglia di prelevare le piastrelle da 5/6 scatole contemporaneamente.

For best installation results, we suggest taking the tiles from 5/6 boxes at the same time.

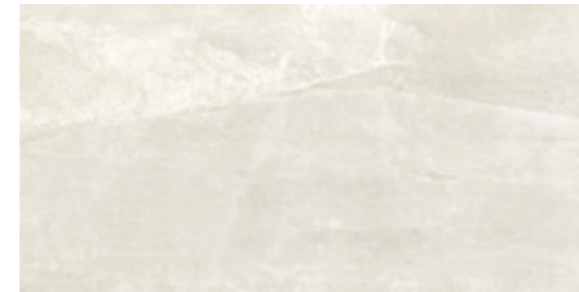

± 9,5

60×120 - 24"×48"

**03976A** | Ibla Linfa Nat/Ret  
**03980A** | Ibla Linfa Lap/Ret

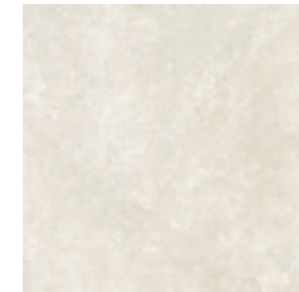

± 9,5

60×60 - 24"×24"

**03984A** | Ibla Linfa Nat/Ret  
**03988A** | Ibla Linfa Lap/Ret



28,2×28,5 - 11"×11½"

**04007A** | Opus Linfa Mix Lap/Nat

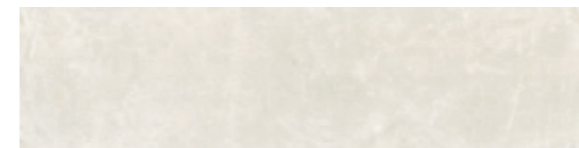

± 9,5

30×120 - 12"×48"

**03992A** | Ibla Linfa Nat/Ret

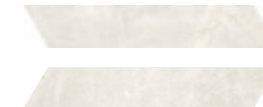

10×53 - 4"×20"

**04016** | Chevron Linfa Nat/Ret  
**04021** | Chevron Linfa Lap/Ret



30×30 - 12"×12"

**04012** | Ragusa Linfa Mix Lap/Nat



60×120 - 24"×48"

**04004A** | Ibla Zagara Light Nat/Ret

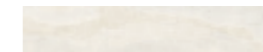

10×60 - 4"×24"

**04025** | Listoncino Linfa Nat/Ret  
**04029** | Listoncino Linfa Lap/Ret



60×120 - 24"×48"

**04002A** | Ibla Tombolo Light Lap/Ret

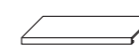





Gres fine porcellanato ad impasto colorato  
Tecnologia Synchro Digit Piemme

Coloured-body fine porcelain stoneware  
Synchro Digit Piemme Technology

Feinsteinzeug aus farbiger Masse  
Synchro Digit Piemme Technologie

Grès cérame fin à pâte colorée  
Technologie Synchro Digit Piemme

# Ibla Colofonia

Per un risultato di posa ottimale si consiglia di prelevare le piastrelle da 5/6 scatole contemporaneamente.

For best installation results, we suggest taking the tiles from 5/6 boxes at the same time.

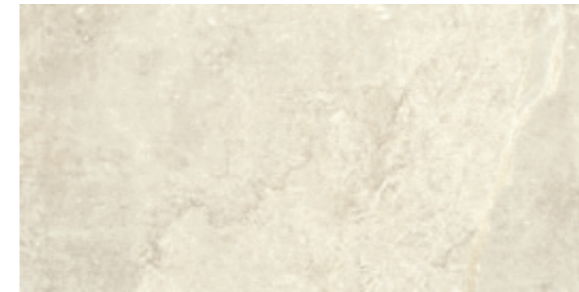

± 9,5

60×120 - 24"×48"

**03977A** | Ibla Colofonia Nat/Ret  
**03981A** | Ibla Colofonia Lap/Ret  
**05273** | Ibla Colofonia Antislip/Ret

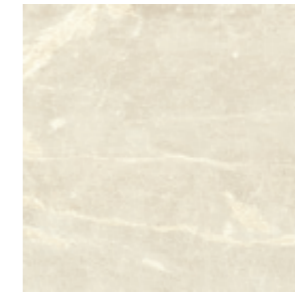

± 9,5

60×60 - 24"×24"

**03985A** | Ibla Colofonia Nat/Ret  
**03989A** | Ibla Colofonia Lap/Ret



28,2×28,5 - 11"×11½"

**04008** | Opus Colofonia Mix Lap/Nat



± 9,5

30×120 - 12"×48"

**03993A** | Ibla Colofonia Nat/Ret  
**03997A** | Ibla Colofonia Lap/Ret



10×53 - 4"×20"

**04017** | Chevron Colofonia Nat/Ret  
**04022** | Chevron Colofonia Lap/Ret



30×30 - 12"×12"

**04013** | Ragusa Colofonia Mix Lap/Nat



10×60 - 4"×24"

**04026** | Listoncino Colofonia Nat/Ret  
**04031** | Listoncino Colofonia Lap/Ret

Pezzi speciali  
Special pieces



Battiscopa 4,5×60 ± 9,5



Gradino Costa Retta 33×120 ± 9,5





Gres fine porcellanato ad impasto colorato  
Tecnologia Synchro Digit Piemme

Coloured-body fine porcelain stoneware  
Synchro Digit Piemme Technology

Feinsteinzeug aus farbiger Masse  
Synchro Digit Piemme Technologie

Grès cérame fin à pâte colorée  
Technologie Synchro Digit Piemme

# Ibla Resina

Per un risultato di posa ottimale si consiglia di prelevare le piastrelle da 5/6 scatole contemporaneamente.

For best installation results, we suggest taking the tiles from 5/6 boxes at the same time.



± 9,5

60x120 - 24"x48"

**03978A** | Ibla Resina Nat/Ret  
**03982A** | Ibla Resina Lap/Ret  
05274 | Ibla Resina Antislip/Ret



± 9,5

60x60 - 24"x24"

**03986A** | Ibla Resina Nat/Ret  
**03990A** | Ibla Resina Lap/Ret



28,2x28,5 - 11"x11½"

**04009** | Opus Resina Mix Lap/Nat



± 9,5

30x120 - 12"x48"

**03994A** | Ibla Resina Nat/Ret  
**03998A** | Ibla Resina Lap/Ret

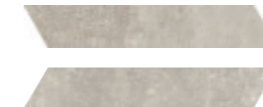

10x53 - 4"x20"

**04018** | Chevron Resina Nat/Ret  
**04023** | Chevron Resina Lap/Ret



30x30 - 12"x12"

**04014** | Ragusa Resina Mix Lap/Nat



60x120 - 24"x48"

**04005A** | Ibla Zagara Mid Nat/Ret

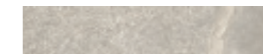

10x60 - 4"x24"

**04027** | Listoncino Resina Nat/Ret  
**04032** | Listoncino Resina Lap/Ret

Pezzi speciali  
Special pieces



Battiscopa 4,5x60 ± 9,5

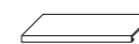

Gradino Costa Retta 33x120 ± 9,5





# Ibla Nera

Per un risultato di posa ottimale si consiglia di prelevare le piastrelle da 5/6 scatole contemporaneamente.

For best installation results, we suggest taking the tiles from 5/6 boxes at the same time.



± 9,5

60×120 - 24"×48"

**03975A** | Ibla Nera Nat/Ret  
**03979A** | Ibla Nera Lap/Ret

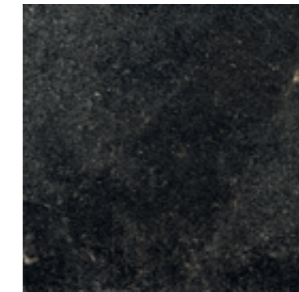

± 9,5

60×60 - 24"×24"

**03983A** | Ibla Nera Nat/Ret  
**03987A** | Ibla Nera Lap/Ret



28,2×28,5 - 11"×11½"

**04006** | Opus Nera Mix Lap/Nat

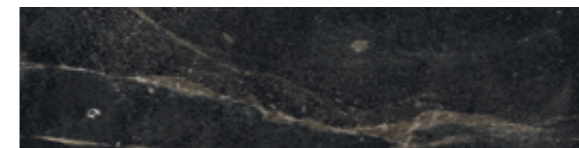

± 9,5

30×120 - 12"×48"

**03991A** | Ibla Nera Nat/Ret  
**03995A** | Ibla Nera Lap/Ret



10×53 - 4"×20"

**04015** | Ibla Chevron Nera Nat/Ret  
**04019** | Ibla Chevron Nera Lap/Ret



30×30 - 12"×12"

**04011** | Ragusa Nera Mix Lap/Nat



60×120 - 24"×48"

**04003A** | Ibla Zagara Dark Nat/Ret



10×60 - 4"×24"

**04024** | Listoncino Nera Nat/Ret  
**04028** | Listoncino Nera Lap/Ret

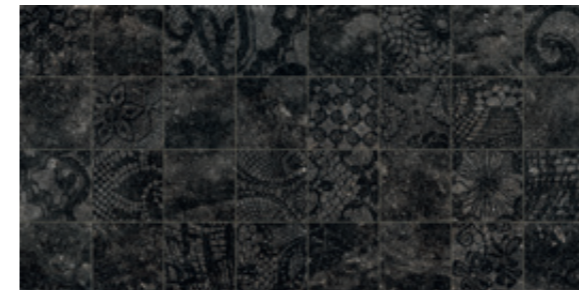

60×120 - 24"×48"

**04001A** | Ibla Tombolo Dark Lap/Ret

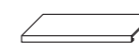



# Riepilogo Gamma

Collection  
Serie  
Gamme

Formati Sizes	60*120 24"×48"	30*120 12"×48"	60*60 24"×24"	Listoncino 10*60 4"×24"	Chevron 10*53 4"×20"						
	± 9,5	± 9,5	± 9,5	± 9,5	± 9,5	DIN 51130	DIN 51097	DCOF	BS EN 7976-2	AS4586 2013	
Ibla Linfa	Nat/Ret	03976A	03992A	03984A	04025	04016	R10	A+B	>0.42	wet, dry >36	P3
	Lap/Ret	03980A	03996A	03988A	04029	04021	V3	R9	A	>0.42	
	Lap/Nat										
Ibla Colofonia	Nat/Ret	03977A	03993A	03985A	04026	04017	R10	A+B	>0.42	wet, dry >36	P3
	Lap/Ret	03981A	03997A	03989A	04031	04022	V3	R9	A	>0.42	
	Antislip/Ret	05273					R11	A+B+C	>0.42	wet, dry >36	P4
	Lap/Nat										
Ibla Resina	Nat/Ret	03978A	03994A	03986A	04027	04018	R10	A+B	>0.42	wet, dry >36	P3
	Lap/Ret	03982A	03998A	03990A	04032	04023	V3	R9	A	>0.42	
	Antislip/Ret	05274					R11	A+B+C	>0.42	wet, dry >36	P4
	Lap/Nat										
Ibla Nera	Nat/Ret	03975A	03991A	03983A	04024	04015	R10	A+B	>0.42	wet, dry >36	P3
	Lap/Ret	03979A	03995A	03987A	04028	04019	V3	R9	A	>0.42	
	Lap/Nat										

Zagara 60*120 24"×48"	Tombolo 60*120 24"×48"	Opus Mix 28,2*28,5 11"×11¼"	Ragusa Mix 30*30 12"×12"	Gradino Costa Retta 33*120 13"×48"	Battiscopa 4,5*60 1¼"×24"
± 9,5	± 9,5	± 9,5	± 9,5	± 9,5	± 9,5
04004A	04002A			04043A	04034
		04007	04012	04047A	04038
				04044A	04035
				04048A	04039
		04008	04013		
04005A				04045A	04036
				04049A	04041
		04009	04014		
04003A				04042A	04033
	04001A			04046A	04037
		04006	04011		

# Imballi

Packing  
Verpackung  
Emballage

Formati Sizes	± MM	Pezzi Scatola Pieces/Box Stck/Karton Carreaux/Boite	Mq/Scatola Sqmt/Box Qm/Karton M2/Boite	Kg/Scatola Kgs/Box Kg/Karton Kg/Boite	Scatole/Paletta Boxes/Pallet Karton/Palette Boite/Palette	Mq/Paletta Sqmt/Pallet Qm/Pallet M2/Palette	Kg/Paletta Kgs/Pallet Kg/Pallet Kg/Palette	Formato Paletta Size Pallet Format Pallet Dim. Palette	
60*120 (24"×48") Nat/Ret - Lap/Ret	P	9,5	2	1,44	31,00	30	43,20	930	122x80x96
30*120 (12"×48") Nat/Ret - Lap/Ret	P	9,5	4	1,44	31,00	36	51,84	1116	124x80x96
60*60 (24"×24") Nat/Ret - Lap/Ret	P	9,5	4	1,44	29,00	32	46,08	928	120x80x75
60*120 (24"×48") Tombolo Lap/Ret	P	9,5	2	1,44	31,00	30	43,20	930	122x80x96
60*120 (24"×48") Zagara Nat/Ret	P	9,5	2	1,44	31,00	30	43,20	930	122x80x96
10*60 (4"×24") Listoncino Nat/Ret - Lap/Ret	P	9,5	10	0,60	12,50	72	43,20	900	120*80*75
10*53 (4"×20") Chevron Nat/Ret - Lap/Ret	P	9,5	12	0,636	13,20	60	38,16	792	120x80x75
28,2*28,5 (11"×11¼") Opus Mix Lap/Nat	P	9,5	6	0,482	9,5	60	-	-	-
30*30 (12"×12") Ragusa Mix Lap/Nat	P	9,5	5	0,45	8,5	60	-	-	-
Pezzi Speciali / Special Pieces									
33*120 (13"×48") Gradino Costa Retta Nat/Ret - Lap/Ret	P	9,5	2	0,792	18,50	20	-	-	-
4,5*60 (1¼"×24") Battiscopa Nat/Ret - Lap/Ret	P	9,5	14	0,378 m.l. 8,40	8,00	80	-	-	-



# Pezzi Speciali

Special pieces  
Formstücke  
Pièces spéciales

Battiscopa Nat/Ret 4,5x60 – 1¾”x24” ± 9,5  
Battiscopa Lap/Ret 4,5x60 – 1¾”x24” ± 9,5

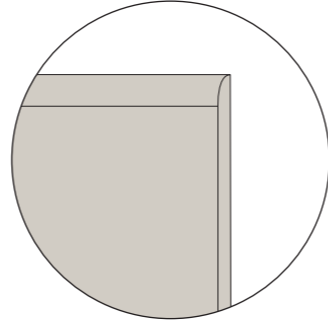

Gradino Costa Retta Nat/Ret 33x120 – 13”x48” ± 9,5  
Gradino Costa Retta Lap/Ret 33x120 – 13”x48” ± 9,5  
(costa retta ottenuto per taglio e incollaggio - obtained by cutting and gluing)

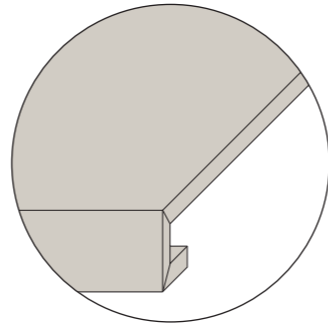

# Caratteristiche Tecniche

Technical characteristics  
Technische daten  
Caracteristiques techniques

CLASSIFICAZIONE SECONDO NORME EN 14411 BI<sub>A</sub> – ISO 13006 – CLASSIFICATION IN ACCORDANCE WITH EN 14411 BI<sub>A</sub> – ISO 13006  
KLASSIFIZIERUNG GEMÄSS NORMEN EN 14411 BI<sub>A</sub> – ISO 13006 – CLASSIFICATION SELON LES NORMES EN 14411 BI<sub>A</sub> – ISO 13006

CARATTERISTICA TECNICA TECHNICAL CHARACTERISTIC TECHNISCHE DATEN CARACTÉRISTIQUE TECHNIQUE	NORMA NORM NORM NORME	VALORE PRESCRITTO VALUE REQUIRED NORMVORGABE VALEUR PRESCRIPTE	VALORE MEDIO MEAN VALUE MITTELWERT VALEUR MOYENNE	NORMA NORM NORM NORME	VALORE MEDIO MEAN VALUE MITTELWERT VALEUR MOYENNE	
LUNGHEZZA E LARGHEZZA LENGHT AND WIDTH / LÄNGE UND BREITE / LONGUEUR ET LARGEUR		±0.6% (±2.00 MM)				
SPESORE THICKNESS / STÄRKE / ÉPAISSEUR		±5% (±0.5 MM)				
RETTILINEITÀ LATI WARPAGES OF EDGES / GERADHEIT DER KANTEN / RÉCTITUDE DES ARÊTES	ISO 10545.2	±0.5% (±1.5 MM)	CONFORME IN ACCORDANCE ERFÜLLT CONFORME	ASTM C-499 ASTM C-485 ASTM C-502	IN ACCORDANCE	
ORTOGONALITÀ WEDGING / RECHTWINKLIGKEIT / ORTHOGONALITÉ		±0.5% (±2.00 MM)				
PLANARITÀ FLATNESS / PLANITÄT / PLANIMÉTRIE		±0.5% (±2.00 MM)				
ASSORBIMENTO % D'ACQUA WATER ABSORPTION WASSERANNAHME % ABSORPTION D'EAU %	ISO 10545.3	≤ 0.5%	CONFORME IN ACCORDANCE ERFÜLLT CONFORME	ASTM C-373	IN ACCORDANCE	
RESISTENZA ALLA FLESSIONE BENDING STRENGTH BIEGEZUGFESTIGKEIT RÉSISTANCE À LA FLEXION	ISO 10545.4	Modulus of rupture (average): R ≥ 35N/mm <sup>2</sup> Breaking strength for thickness 7.5 mm S S > 1300 N	CONFORME IN ACCORDANCE ERFÜLLT CONFORME	ASTM C-648 250 LBS OR GREATER	IN ACCORDANCE	
DILATAZIONE TERMICA LINEARE TRA 20° E 100° C LINEAR THERMAL EXPANSION BETWEEN 20° AND 100° C LINEARE WÄRMEAUSSDEHNUNG ZWISCHEN 20° UND 100° C DILATATION THERMIQUE LINEAIRE ENTRE 20° ET 100° C	ISO 10545.8	SECONDO I DATI DEL COSTRUTTORE ACCORDING TO BUILDERS SPECIFICATIONS LAUT ANGABEN DES HERSTELLERS SELON LES ELEMENTS DU COSTRUCTEUR	≈ 7X10 <sup>-6</sup> C <sup>-1</sup>			
RESISTENZA AGLI SBALZI TERMICI THERMAL SHOCK RESISTANCE TEMPERATURWECHSELBESTÄNDIGKEIT RÉSISTANCE AUX ÉCARTS DE TEMPÉRATURE	ISO 10545.9	RICHIESTA REQUEST BITTE DEMANDE	RESISTENTE RESISTANT WIDERSTEHEND RÉSISTANT			
RESISTENZA AL GELO FROST RESISTANCE FROSTBESTÄNDIGKEIT RÉSISTANCE AU GEL	ISO 10545.12	RICHIESTA REQUEST BITTE DEMANDE	RESISTENTE RESISTANT WIDERSTEHEND RÉSISTANT	ASTM C-1026	IN ACCORDANCE	
RESISTENZA ALL'ATTACCO CHIMICO RESISTANCE TO CHEMICAL ATTACK BESTÄNDIGKEIT GEGEN CHEMIKALIEN RÉSISTANCE À L'ATTAQUE CHIMIQUE	ISO 10545.13	SECONDO I DATI DEL COSTRUTTORE ACCORDING TO BUILDERS SPECIFICATIONS LAUT ANGABEN DES HERSTELLERS SELON LES ELEMENTS DU COSTRUCTEUR	RESISTENTE RESISTANT WIDERSTEHEND RÉSISTANT	ASTM C-650	IN ACCORDANCE	
RESISTENZA DEI COLORI ALLA LUCE COLOURS RESISTANCE TO LIGHT LICHTBESTÄNDIGKEIT RÉSISTANCE DES COULEURS À LA LUMIÈRE	DIN 51094	NESSUNA ALTERAZIONE NO ALTERATION KEINE VERÄNDERUNG AUCUNE ALTÉRATION	CONFORME IN ACCORDANCE ERFÜLLT CONFORME			
RESISTENZA ALLE MACCHIE STAIN RESISTANCE FLECKENFESTIGKEIT RÉSISTANCE AUX TACHES	ISO 10545.14	CLASSE 3 METODO DI PROVA DISPONIBILE TEST METHOD AVAILABLE VERFÜGBARE PRÜFMETHODE METHODE D'ESSAI DISPONIBILE	CONFORME IN ACCORDANCE ERFÜLLT CONFORME			
RESISTENZA ALLO SCIVOLAMENTO SLIPAGE RESISTANCE RUTSCHSICHERHEIT RÉSISTANCE AU GLISSEMENT	DIN 51130 *	9 ≤ R ≤ 13	NAT LAP ANTISLIP	R10 R9 R11	ASTM C-1028 * COF ≥ 0.6 dry ≥ 0.6 wet	NAT LAP ANTISLIP
	DIN 51097 *	A,B,C	NAT LAP ANTISLIP	A+B A A+B+C	ANSI * 137.1-2012 DCOF > 0.42 WET	NAT LAP ANTISLIP
	BS EN 7976-2*	> 36 DRY > 36 WET	NAT LAP ANTISLIP	Dry/Wet > 36	AS 4586: 2013 CLASS	NAT LAP ANTISLIP
						P3 P4

\*TRATTANDOSI DI NORMATIVE NAZIONALI, I METODI DI PROVA, I REQUISITI E LE CLASSIFICAZIONI VARIANO DA PAESE A PAESE. IL VALORE ATTESO DALLA RESISTENZA ALLO SCIVOLAMENTO DELLA PRODUZIONE DI INDUSTRIE CERAMICHE PIEMME S.P.A., PUÒ VARIARE IN BASE AL LOTTO PRODUTTIVO. SPECIFICA DOCUMENTAZIONE È DISPONIBILE SU RICHIESTA.  
TEST METHODS, REQUIREMENTS AND CLASSIFICATIONS DIFFER FROM COUNTRY TO COUNTRY, ACCORDING TO THE NATIONAL REGULATIONS. THE EXPECTED VALUE OF SLIPAGE RESISTANCE OF PRODUCTS BY INDUSTRIE CERAMICHE PIEMME S.P.A. MAY VARY DEPENDING ON THE PRODUCTION BATCH. SPECIFIC DOCUMENTS ARE AVAILABLE UPON REQUEST.  
PRÜFVERFAHREN, ERFORDERNISSE UND KLASSIFIKATIONEN SIND VERSCHIEDEN VON LAND ZU LAND, GEMÄSS DER NATIONALEN VORSCHRIFTEN. DER ERWARTUNGSWERT DER RUTSCHSICHERHEIT DER PRODUKTE VON INDUSTRIE CERAMICHE PIEMME S.P.A. KANN SICH - JE NACH DER PRODUKTIONSPARTIE - VERÄNDERN. SPEZIFISCHE UNTERLAGEN SIND AUF VERLANGEN ZUR VERFÜGUNG.  
LES MÉTHODES D'ESSAI, LES RÉQUISITIONS ET LES CLASSIFICATIONS CHANGENT DE PAYS À PAYS, SELON LES RÉGLEMENTATIONS NATIONALES. LA VALEUR ATTENDUE DE RÉSISTANCE AU GLISSEMENT DES PRODUITS DE INDUSTRIE CERAMICHE PIEMME S.P.A. PEUT VARIER EN FONCTION DU LOT DE PRODUCTION. UNE DOCUMENTATION SPÉCIFIQUE EST DISPONIBLE SUR DEMANDE.

ELENCO DELLE SERIE CERTIFICATE E CLASSIFICAZIONI DISPONIBILI A RICHIESTA - LIST OF CERTIFIED SERIES AND CLASSIFICATIONS AVAILABLE UPON REQUEST  
LISTE DER GEPRÜFTEN SERIE UND KLASSIFIZIERUNGEN AUF ANFRAGE ERHÄLTICH - LISTE DES SERIES CERTIFIÉES ET DES CLASSEMENTS DISPONIBLES SUR DEMANDE



CERAMICHE PIEMME  
FLOOR AND MORE





# Norme per la posa e la manutenzione

## Installation and maintenance instructions

### Verlegung, reiningung und pflege

#### Guide a la pose et l'entretien

- Per i prodotti rettificati consigliamo una fuga di 2 mm per un migliore risultato di posa.
- Per una migliore resa estetica Piemme consiglia stuccature colorate in tinta con le piastrelle. Verificare, prima dell'utilizzo, la compatibilità ed idoneità dei riempitivi per fughe con il prodotto ceramico.
- Rimuovere le eccedenze dei riempitivi per fughe quando gli stessi sono ancora freschi.
- Attenersi scrupolosamente alle istruzioni indicate dai produttori dei riempitivi per fughe.
- Per eliminare completamente i residui di posa, che potrebbero compromettere la manutenzione ordinaria e le caratteristiche del prodotto, a posa ultimata, procedere con la pulizia utilizzando prodotti adeguati, a base Acida max 3%, rispettando le indicazioni del produttore. Osservare assolutamente i limiti di tempo indicati nelle istruzioni: un contatto troppo pro lungato con questi prodotti potrebbe provocare il danneggiamento della superficie.
- Gli eventuali aloni che si dovessero presentare dopo la posa di materiali lappati o levigati si potranno facilmente eliminare utilizzando un prodotto idoneo, a base Alcalina.
- Riguardo l'utilizzo di materiali ceramici all'esterno, pure riconfermando l'ingelività dei prodotti Piemme in gres porcellanato, in conformità alle vigenti normative europee EN 14411/ISO 13006-ISO 10545.12, occorre attenersi ad alcune fondamentali norme previste per la posa all'esterno, atte a rendere inattaccabili al gelo i predetti pavimenti. Le condizioni più importanti da rispettare sono: le opportune pendenze, le impermeabilizzazioni, i giunti di dilatazione, e l'uso di idonei materiali per la posa.
- Decorì realizzati con smalti e metalli preziosi è indispensabile proteggere la superficie durante la posa, non utilizzare assolutamente prodotti abrasivi e/o acidi, ma solo acqua e sapone neutro. Il produttore non risponde di eventuali danni a questi preziosi materiali causati da "sfregamenti" durante la posa in opera. Per nessun motivo saranno accettate contestazioni relative a materialeposato.

TIPO DI SPORCO	INDICAZIONI PER LA PULIZIA
Birra, Caffè, Gelato, Vino Gomma Pneumatico, Grassi vegetali e animali, Inchiostri, Lampostil Olii Meccanici, Residui di scotch Olio di lino, PennarelloResine Smalti, Tintura per capelli	Prodotti a Base Alcalina
Cera protettiva anti-abrasione, Depositi calcarei, Macchie di ruggine	Prodotti a Base Acida
Cera di candela, Residui di scotch	Solventi
Per ulteriori informazioni specifiche consultare l'area tecnica sul sito Piemme: <a href="http://www.ceramichepiemme.it">www.ceramichepiemme.it</a>	

- For better installation results of rectified products, we suggest 2 mm joint.
- For a better aesthetic finish, Piemme recommends using jointing colours that match the tiles.
- Please check, before using, the compatibility and suitability of grouting material with the ceramic tile.
- Clean away the excess of grouting materials while they are still fresh.
- Follow carefully the instructions pointed out by the producers of tile grouting materials.
- To completely eliminate installation residues, which could negatively affect routine maintenance and product characteristics once installation has terminated, proceed to clean using adequate products, with max. 3% Acid base, following the manufacturer's instructions. Always closely abide by the time limits indicated in the instructions: prolonged contact with these products may cause damage to the surface.
- Any rims that appear after installing lapped or polished materials can be easily eliminated using a suitable Alkaline-based product.
- With regard to the use of ceramic materials outdoors, while once more reiterating that Piemme porcelain stoneware products are frost-proof, in compliance with applicable European standards EN 14411/ISO 13006-ISO 10545.12, a number of fundamental procedures must be followed for outdoor installation, suitable for making the aforementioned floors resistant to frost. The most important aspects are: suitable gradients, waterproofing, expansion joints, and the use of suitable installation materials.
- Decorations made with glazes and precious metals It is most important to protect the surface during installation. Never use abrasive and/or acid products, only water and neutral soap. The manufacturer disclaims liability in case of any damage to these precious materials caused by "rubbing" during installation. Under no circumstances will disputes be accepted relating to the installed material.

TYPE OF STAIN	CLEANING SUGGESTIONS
beer, coffee, wine, ice cream vegetable and animal fats, rubber, remains of scotch tape, grease from machines, linseed oil, felt tip pens, paints, inks, hair dye	Alkaline-based detergent
protective anti-abrasion wax, calcareous residuals, rust stains	Acid-based detergent
candle wax, remains of scotch-tape	Solvents
For further specific details please visit the technical area on Piemme website: <a href="http://www.ceramichepiemme.it">www.ceramichepiemme.it</a>	

- Damit sich eine bessere Verlegung von geschliffenen Produkten ergibt, empfehlen wir eine Fugenbreite von 2 mm.Für ein optisch perfektes Ergebnis empfiehlt Piemme, die Fugen farblich auf die Fliesen abzustimmen.
- Prüfen sie bitte, vor der Verwendung, die Zweckmäßigkeit und die Verträglichkeit des Fugenfüllmittels mit den Keramikfliesen.
- Bitte entfernen sie das überflüssige Fugenfüllmittel wenn es noch frisch ist.
- Folgen sie bitte sorgfältig die von dem Herstellern des Fugenfüllmills angegebenen Bedienungsvorschriften.
- Zur vollkommenen Entfernung der Verlegerückstände, die die normale Pflege erschweren und die Merkmale des Produkts beeinträchtigen könnten, nach der Verlegung geeignete Reinigungsmittel auf max. 3% Säurebasis verwenden und bei der Reini gung die Hinweise des Herstellers beachten. Die angegebenen Zeiten keinesfalls überschreiten: ein zu lange andauernder Kontakt mit diesen Produkten kann Beschädigungen der Oberfläche verursachen.
- Eventuelle nach der Verlegung von geläpptem oder geschliffenem Material sichtbare Schleier lassen sich einfach mit entsprechenden, alkalischen Produkten entfernen.
- Auch wenn die Piemme-Feinsteinzeugprodukte gemäß den europäischen Normen EN 14411/ISO 13006-ISO 10545.12 frostbeständig sind, müssen beim Einsatz keramischer Materialien im Freien einige Grundregeln beachtet werden, damit die Bodenbeläge nicht vom Frost angegriffen werden können. Die wichtigsten Voraussetzungen sind: korrektes Gefälle, Abdichtung, Dehnungsfugen sowie geeignetes Verlegematerial.
- Dekore mit Glasuren und Edelmetallen Während der Verlegung muss die Oberfläche unbedingt abgedeckt werden. Es dürfen keine scheuernden und/oder säurehaltigen Produkte verwendet werden, sondern ausschließlich Wasser und neutrale Seife. Der Hersteller haftet nicht für eventuelle, während der Verlegung durch Abrieb entstandene Schäden an diesen hochwertigen Materialien. Reklamationen von bereits verlegtem Material werden in keinem Fall akzeptiert.

VERSCHMUTZUNGSART	REINIGUNGSHINWEISE
Bier, Wein, Eis, Kaffee Tierische oder pflanzliche Fette Gummi, Kleberbandresten Schmieröl, Tinte, Leöl, Filzstift, Harz oder Lack, Haarfarbe	Alakalische Reinigungsmittel
Kratzenschutz-Wachs, Kalkablagerunge, Rostflecken	Säure-Reinigungsmittel
Kerzenwachs Kleberbandresten	Lösungsmittel
Weitere Einzelheiten finden Sie in dem technischen Bereich des Piemme website: <a href="http://www.ceramichepiemme.it">www.ceramichepiemme.it</a>	

- Pour obtenir le meilleur résultat de pose de produits rectifiés, il est conseillé de réaliser un joint de 2 mm.
- Pour parfaire l'effet esthétique obtenu, Piemme conseille de confectionner des joints de la même couleur que les carreaux.
- Vérifier avant la pose la compatibilité et convenance des remplissages pour joints avec le produit céramique.
- Enlever les surplus des remplissages pour joints alors qu'ils sont encore frais.
- Respecter scrupuleusement les instructions indiquées par les fabricants de remplissages pour joints.
- Pour éliminer complètement tout résidu de pose pouvant gêner l'entretien courant et altérer les caractéristiques du produit, il est conseillé, à la fin de la pose, de procéder au nettoyage du carrelage avec des produits à base acide maximum 3% et de respecter les consignes du fabricant. Suivre impérativement les délais indiqués dans la notice car le contact trop prolongé de ces produits pourrait endommager la surface.
- Pour éliminer facilement la présence éventuelle de cernes après la pose de carreaux rodés ou polis, utiliser un produit à base alcaline.
- Pour ce qui est de la pose à l'extérieur, bien que les produits Piemme en grès cérame soient ingélifs, conformément aux normes européennes EN 14411/ISO 13006-ISO 10545.12, il convient cependant de respecter quelques règles fondamentales de manière à rendre le carrelage inattaquable au gel. Les conditions les plus importantes à remplir sont: le degré d'inclinaison, l'imperméabilisation, les joints de dilatation et l'utilisation de matériaux de pose appropriés.
- Décors réalisés avec des émaux et des métaux précieux Il est indispensable de protéger la surface pendant la pose. N'utiliser en aucun cas des produits abrasifs et/ou acides mais uniquement de l'eau et du savon neutre. La fabricant ne répond pas des dommages éventuels de ces matériaux précieux causés par le frottement pendant la pose. Aucune réclamation, quelle qu'elle soit, concernant le matériau posé ne sera acceptée.

TYPE DE TACHE	NETTOYAGE CONSEIL
Bière, Vin, Glace, Café, Graisses végétales et animales, Encres, Résidus de scotch, Huile de graissage, Hile de lin Crayon feutre Émaux, Teinture pour cheveux, Caoutchouc pour pneus	Détergents à base alcaline
Cire de protection anti abrasion, Dépôts de calcaire, Tache de rouille	Détergents à base d'acide
Cire de bougie Résidus de scotch	Solvant
Pour d'ultérieures Information spécifiques consulter le département technique du site Piemme: <a href="http://www.ceramichepiemme.it">www.ceramichepiemme.it</a>	

# Guida alla Lettura

## Reading Guide

### Leseanleitung

#### Guide à la lecture

**▼**  
**▲**  
Spessore  
Thickness  
Stärke  
Epaisseur

Variazione nelle sfumature di colore  
Color shade variations  
Variation der Farbnuancen  
Variation des nuances de couleur

Resistenza alla scivolosità  
Skid resistance  
Rutschfestigkeit  
Resistance au glissement

V1

Aspetto uniforme  
Uniform apperance  
Gleichförmiges aussehen  
Aspect uniforme

V2

Variazione leggera  
Slight variation  
Leichte variation  
Variation légère

V3

Variazione moderata  
Moderate variation  
Mäßige variation  
Variation modeste

V4

Variazione casuale  
Random variation  
Zufällige variation  
Variation fortuite

Tutti i formati sono nominali.

All sizes are nominal.

Die Formate sind Nennwerte.

Tous les formats sont nominaux.

Gli spessori riportati in questo catalogo sono nominali e possono variare a seconda dei formati e delle finiture.

The thickness mentioned on this catalogue are nominal and can be different according to the sizes and the finishes.

Die in diesem Katalog angegebenen Fliesenstärke sind nominal und können, je nach Format oder Oberfläche, verschieden sein.

Les épaisseurs reportées sur ce catalogue sont nominales et peuvent varier suivant les formats et les finitions.

I colori e le caratteristiche estetiche dei prodotti sono quanto più possibile vicini a quelli reali, nei limiti consentiti dai processi di stampa.

The colours and appearance features of the products are as close as possible to reality, within the limitation of the printing process.

Die Farben und die ästhetischen Eigenschaften der Produkte entsprechen der Wirklichkeit, innerhalb den von dem Druckverfahren erlaubten Grenzen.

Les couleurs et les caractéristiques esthétiques sont fidèles aux couleurs et caractéristiques réelles dans les limites des procédés d'impression.





Ceramics of Italy rappresenta la volontà dell'industria italiana delle piastrelle di ceramica nel diffondere e promuovere una nuova valenza della piastrella di ceramica: non più solo un prodotto per l'industria delle costruzioni, ma punto di riferimento per stile e creatività per lo sviluppo di una nuova cultura dell'abitare Made in Italy.

Ceramics of Italy represents the willingness of the Italian ceramic tile industry to spread and promote a new concept of ceramic tile: no longer just a product for the construction industry, but a focal point for style and creativity in the development of a new culture of living Made in Italy.



#### Una storia tutta italiana

Piemme dal 1962, anno della sua fondazione, è protagonista indiscussa del vero Made in Italy, quello fatto di eccellenza, passione e creatività. Oggi tutti i materiali Piemme sono prodotti con tecnologia d'avanguardia come la decorazione digitale inkjet HD, la cottura in forni ad energia pulita a recupero di calore, la rettifica e levigatura in linea "one roof" e la verifica elettronica dello standard qualitativo.

#### An all-Italian story

Since 1962, the year of its foundation, Piemme has been the undisputed protagonist of real Made in Italy, that which consists of excellence, passion and creativity. Today, all Piemme materials are made using cuttingedge technology such as HD inkjet digital decoration, firing in heat-recycling cleanenergy kilns, "one roof" grinding and polishing line and electronic quality standard control.

#### Eine ganz italienische Geschichte

Seit dem Gründungsjahr 1962 ist Piemme ein unangefochtener Hauptakteur des echten Made in Italy: jenem, das auf Exzellenz, Leidenschaft und Kreativität gründet. Alle Piemme Erzeugnisse werden heute unter Einsatz von Spitzentechnologie produziert, wie zum Beispiel mit der digitalen Inkjet-Dekoration, dem Brennen in Öfen mit grüner Energie und Wärmerückgewinnung, dem Schleifen und Polieren in der Linie „unter einem Dach“ sowie der elektronischen Prüfung des Qualitätsniveaus.

#### Une histoire toute italienne

Depuis 1962, l'année de sa fondation, Piemme est la protagoniste indiscutée du Made in Italy, basé sur l'excellence, la passion et la créativité. Aujourd'hui toutes les phases du cycle de fabrication Piemme sont issues d'une technologie à l'avant-garde comme la décoration numérique inkjet HD, la cuisson dans des fours à énergie propre et à récupération de chaleur, la rectification et le polissage en en ligne "one roof" et la vérification électronique de la qualité.

**CERAMICHE PIEMME**  
FLOOR AND MORE

INDUSTRIE CERAMICHE PIEMME S.P.A.  
VIA DEL CROCIALE 42/44, 41042 FIORANO (MO) - ITALY  
T. +39 0536.849111 - F. +39 0536.849402  
WWW.CERAMICHEPIEMME.IT - INFO@CERAMICHEPIEMME.IT

